

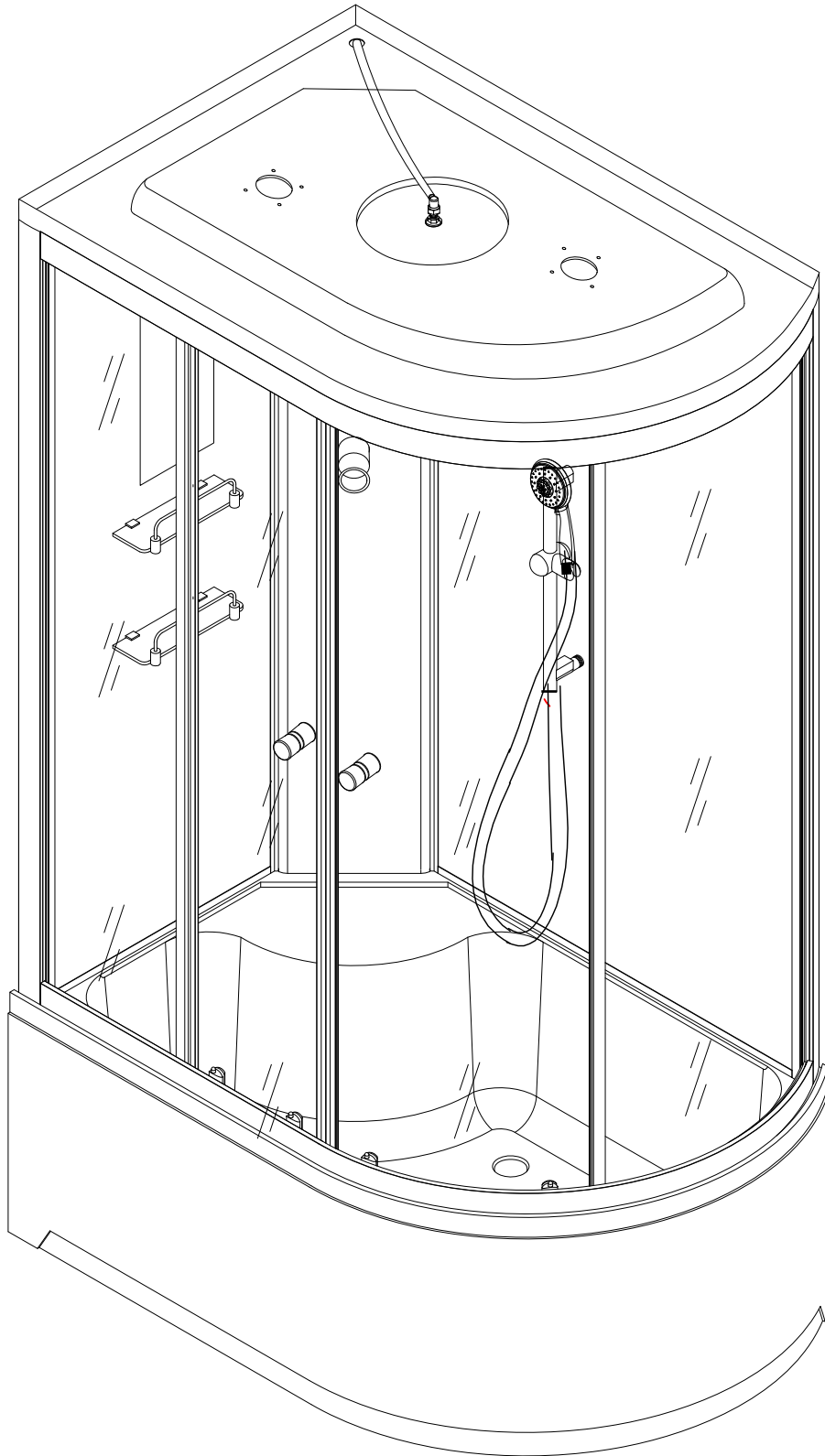

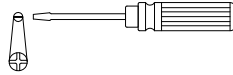

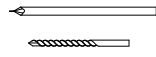

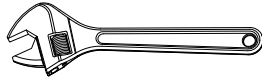

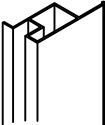
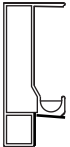
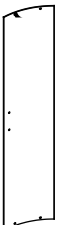

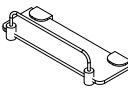

DETO

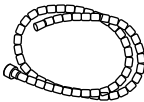
EM4512L/R EM4511L/R

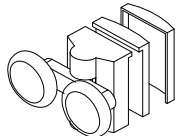
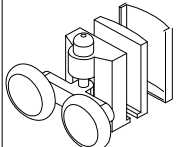
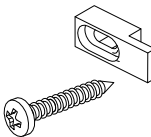
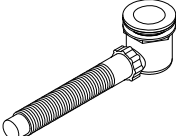
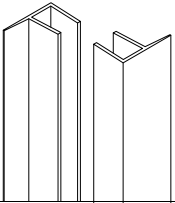
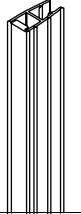
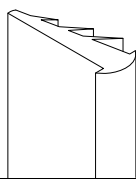
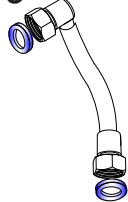
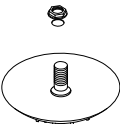
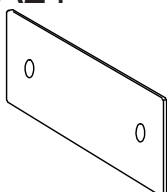
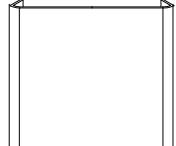

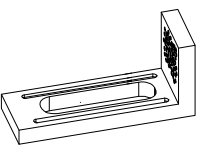
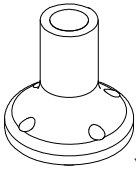

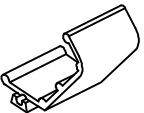
<p>A1</p>  <p>X2</p>	<p>A2</p>  <p>X2</p>	<p>A3</p>  <p>X2</p>	<p>A4</p>  <p>X2</p>	<p>A5</p>  <p>X1</p>
<p>A6</p>  <p>X2</p>	<p>A7</p>  <p>X1</p>	<p>A8</p>  <p>X1</p>	<p>A9</p>  <p>L=1.5M X1</p>	<p>A10</p>  <p>X2</p>
<p>A11</p>  <p>X2</p>	<p>A12</p>  <p>X4</p>	<p>A13</p>  <p>X4</p>	<p>A14</p> <p>ST4X12=4</p>  <p>X4</p>	<p>A15</p> 
<p>A16</p>  <p>X4</p>	<p>A17</p>  <p>X2</p>	<p>A18</p>  <p>X2</p>	<p>A19</p>  <p>X2</p>	<p>A20</p>  <p>X1</p>
<p>A21</p> 	<p>A22</p> 	<p>A23</p>  <p>X4</p>	 <p>X4</p>	<p>A24</p>  <p>X6</p>
<p>M12=29</p> <p>M12=8</p>  <p>L=440MM=4</p> <p>L=180MM=1</p> <p>L=130MM=1</p>	<p>ST4X10= 28</p> <p>ST4X12=8</p> <p>ST4X16=4</p> <p>ST4X40=8</p>	 <p>X5</p>		

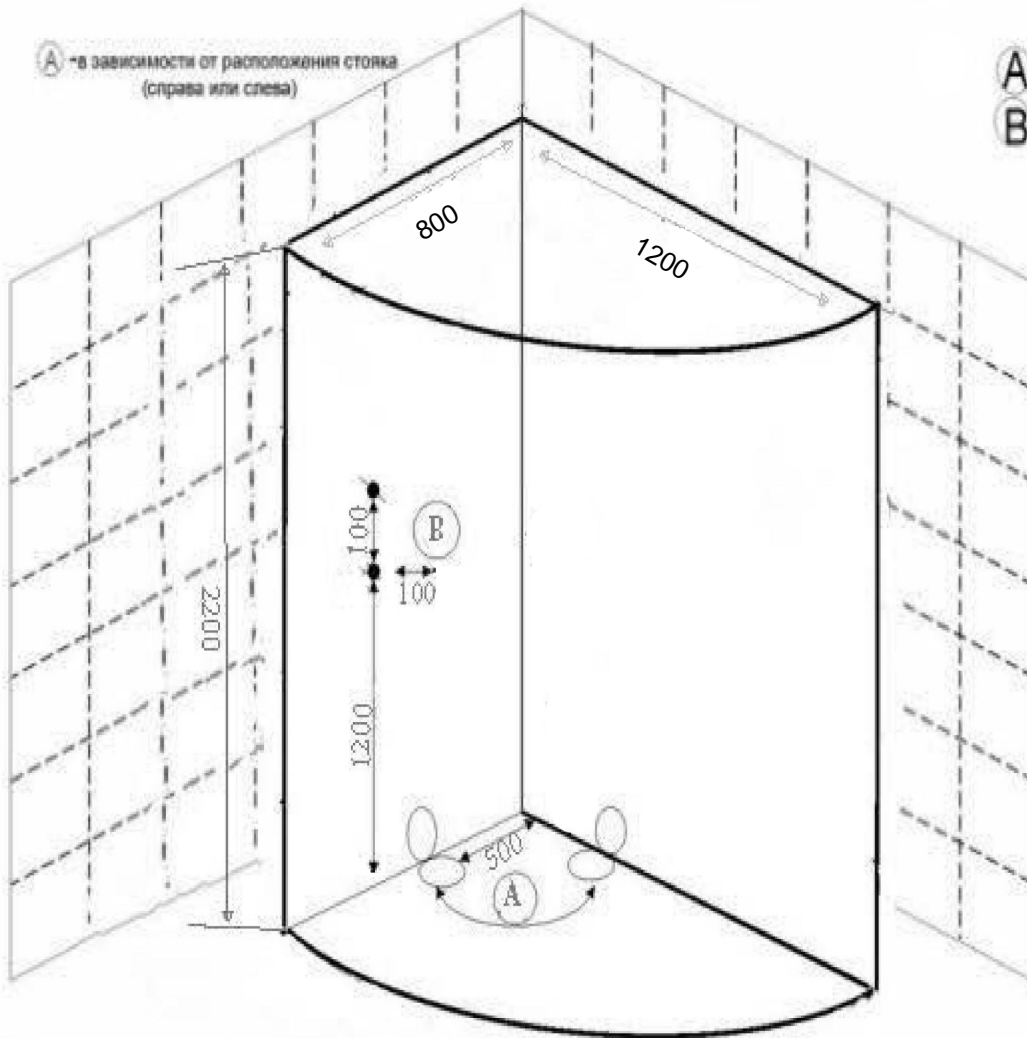

А - в зависимости от расположения стояка (справа или слева)

А - вывод канализации
В - вывод фитингов г/в и х/в

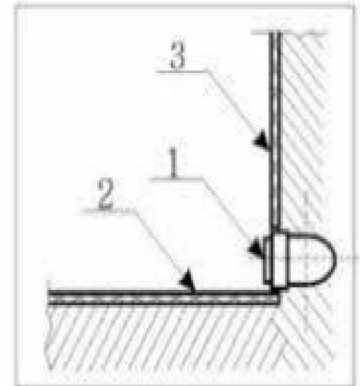

1. Вывод d 50
2. Пол плитка
3. Стена плитка

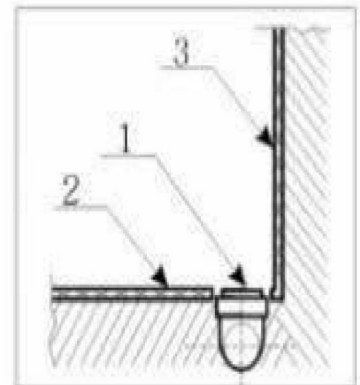

А - Вывод канализации устраивается в уровень с полом из стены или из пола под срез кафельной плитки.

- ✓ Если высота канализации не позволяет вывести на данную высоту вывод, то изготавливается подиум, повторяющий форму кабины (бокса, ванны) с допуском по периметру приблизительно плюс 5 см. Высота подиума зависит от высоты вывода канализации.
- ✓ Подиум, также как и пол под ванной должен быть выложен плиткой.

РАСХОДНЫЕ МАТЕРИАЛЫ.

В КОМПЛЕКТ ПОСТАВКИ НЕ ВХОДЯТ, ПРЕДОСТАВЛЯЮТСЯ ПОКУПАТЕЛЕМ ИЛИ ОПЛАЧИВАЮТСЯ ИМ ПРИ УСТАНОВКЕ

силикон	манжет 40/50	манжет 40/25	тройник 135° 40/40/40	отвод ПВХ 40/90°	сифон латунь	Дополнит. материалы	кран АРКОС® S	угольник SE SFF	труба d40 гофрир.

