

1

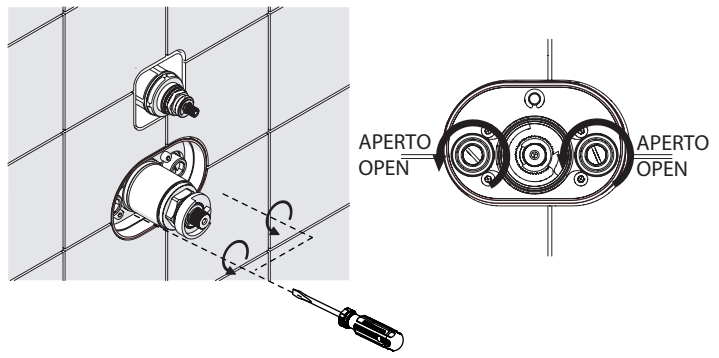

3

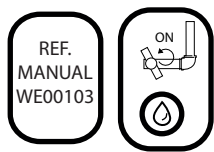
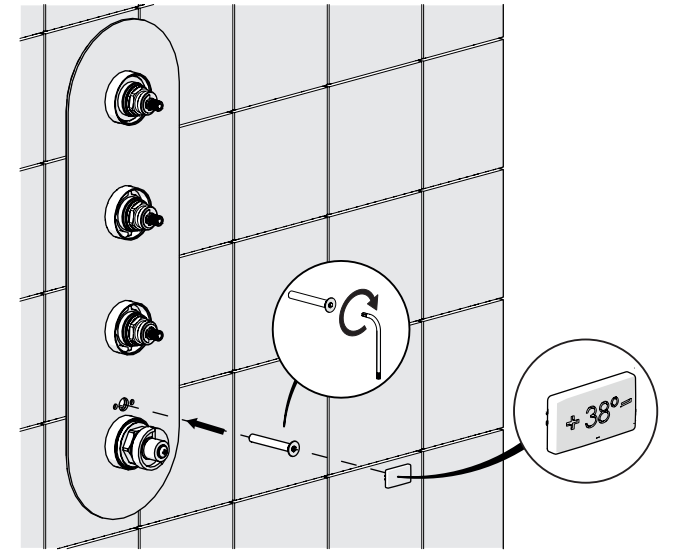

5

2

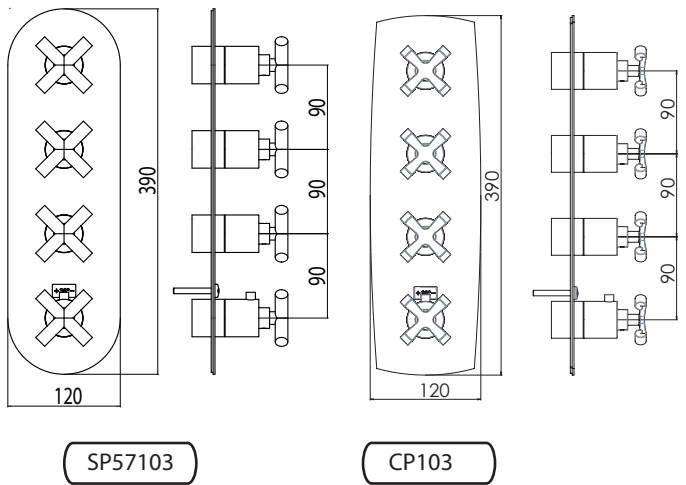

4

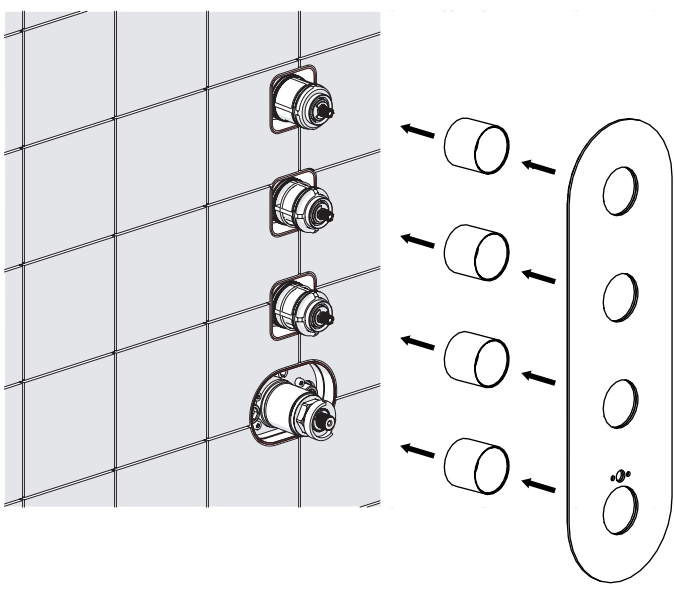

6

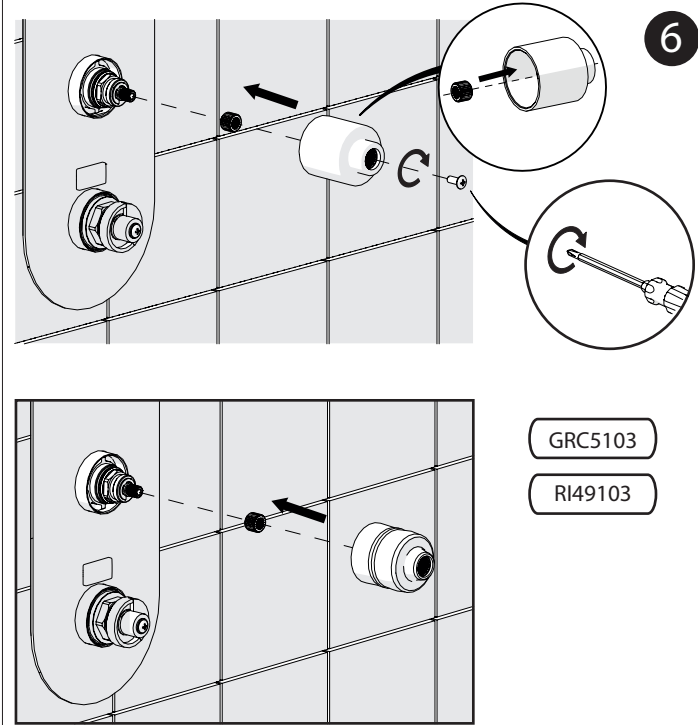

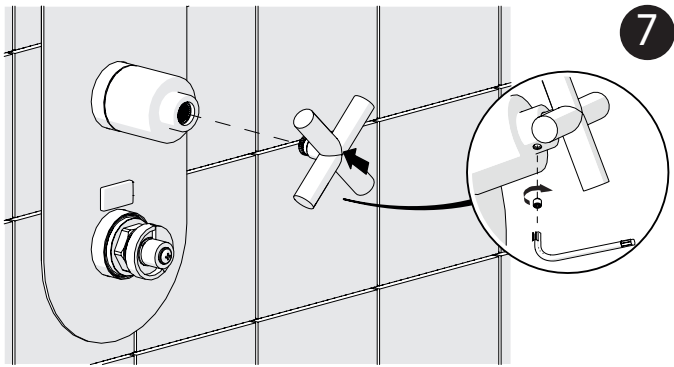

7

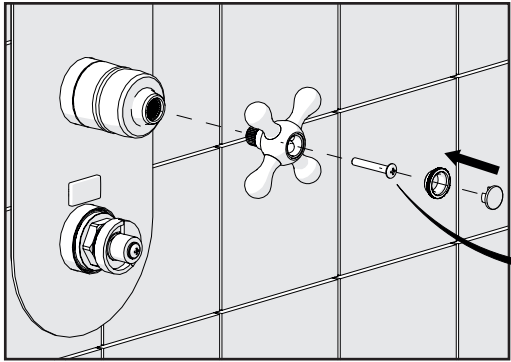

GRC5103
RI49103

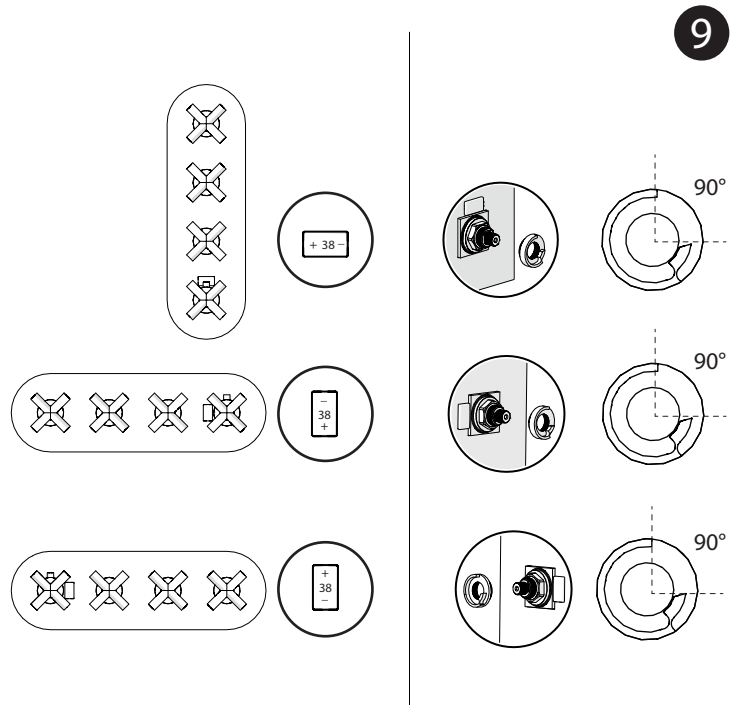
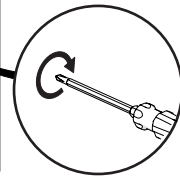

9

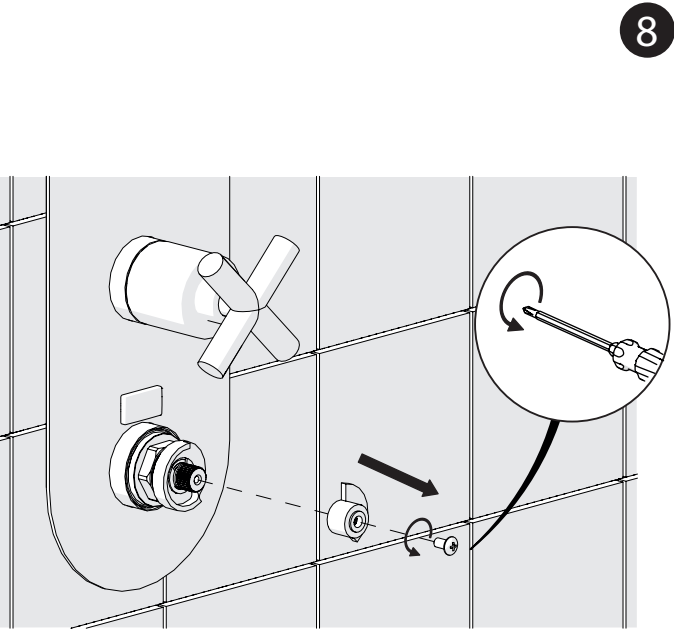
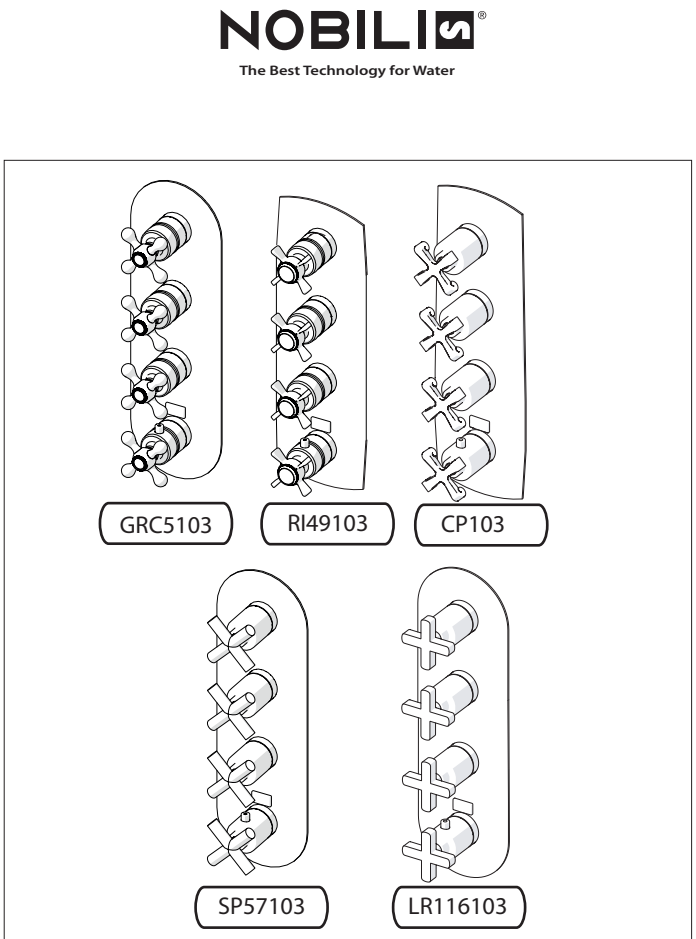

8

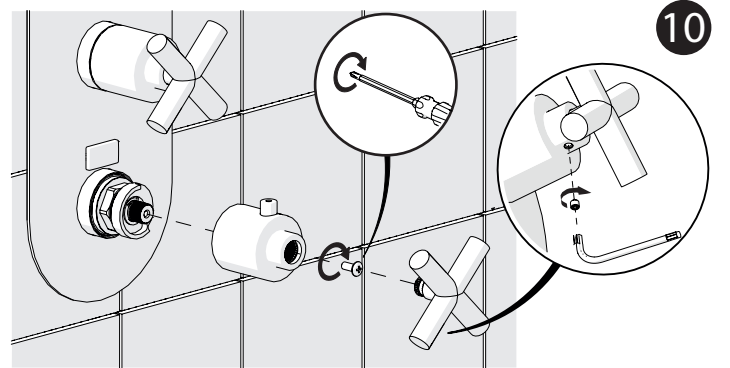

10

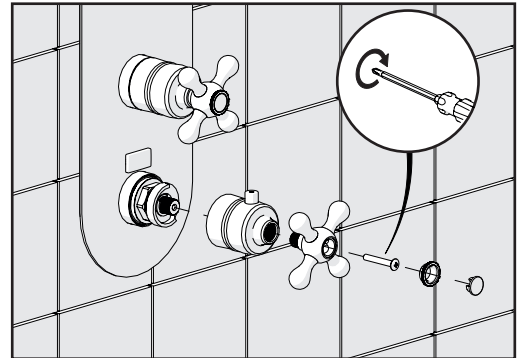

GRC5103
RI49103



PRIMA DI INIZIARE / BEFORE STARTING					
	P bar		MAX 10 MIN 0,5		5
	T		MAX 80 MIN 45		65

PULIZIA / CLEANING				
ACQUA WATER	ALCOOL	MICROFIBRA MICROFIBER	SPUGNA SPONGE	DETERGENTI DETERGENT
✓	✓	✓	✗	✗

Достоверную информацию уточняйте на santehnica.ru.