

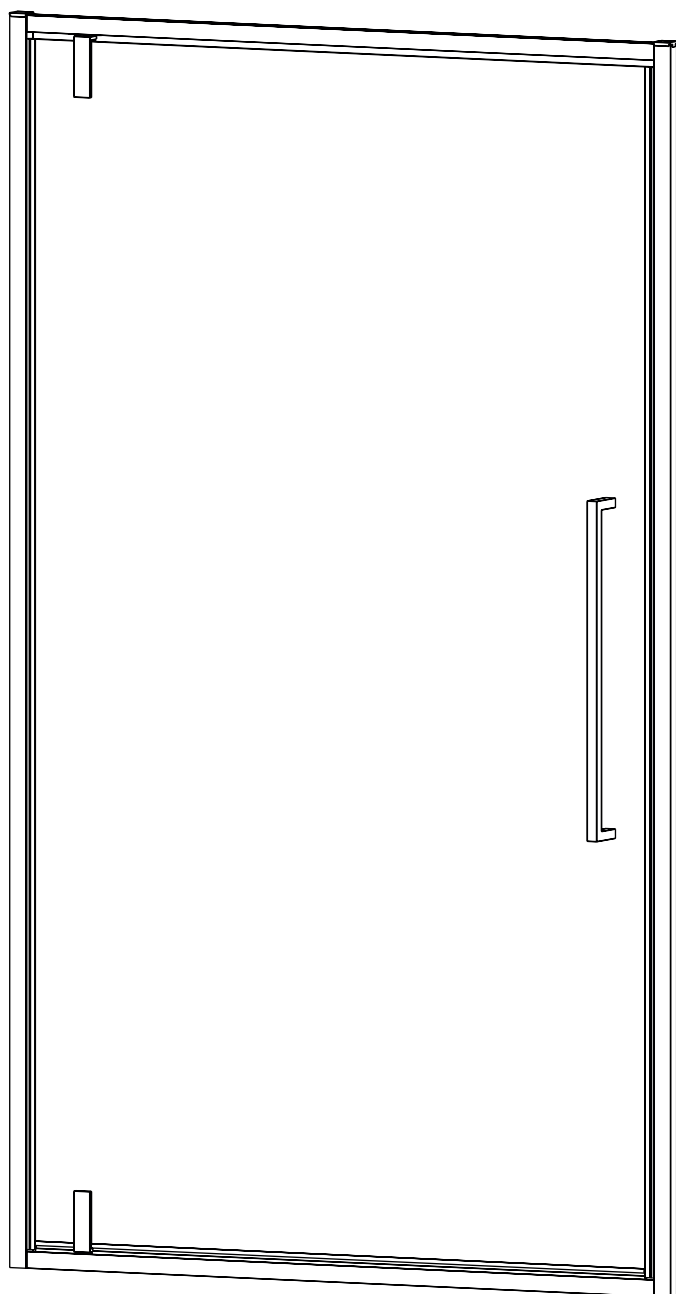

Душевая дверь

VN-33/33B



Инструкция по установке

Пожалуйста, прочитайте инструкцию перед установкой

 Перед установкой поддон для душа должен быть выставлен по уровню и полностью герметичным к плитке.

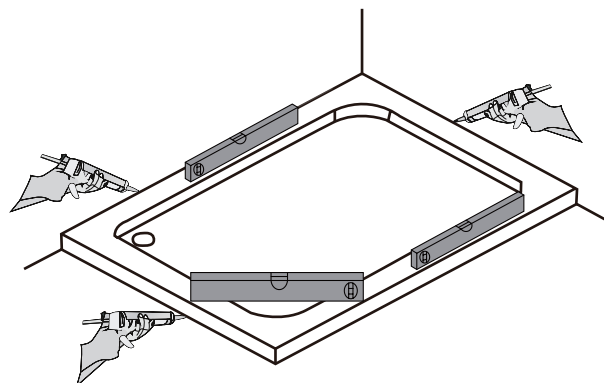

Необходимые инструменты и оборудование



Карандаш

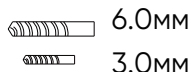

Сверло



Отвертка

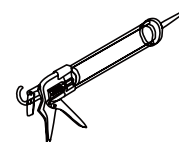

Силикон

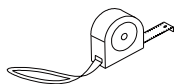

Рулетка



Молоток



Уровень



Дрель

Данная модель с универсальной установкой открывания двери

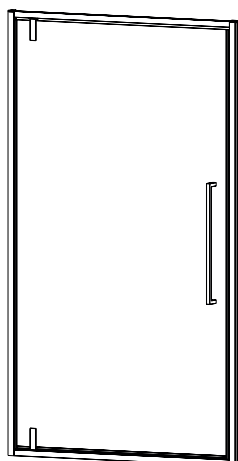

Левая ориентация

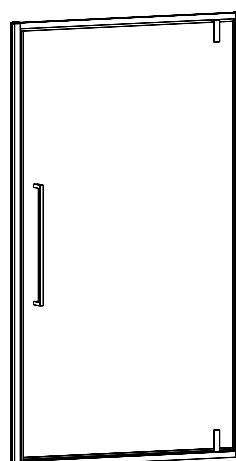





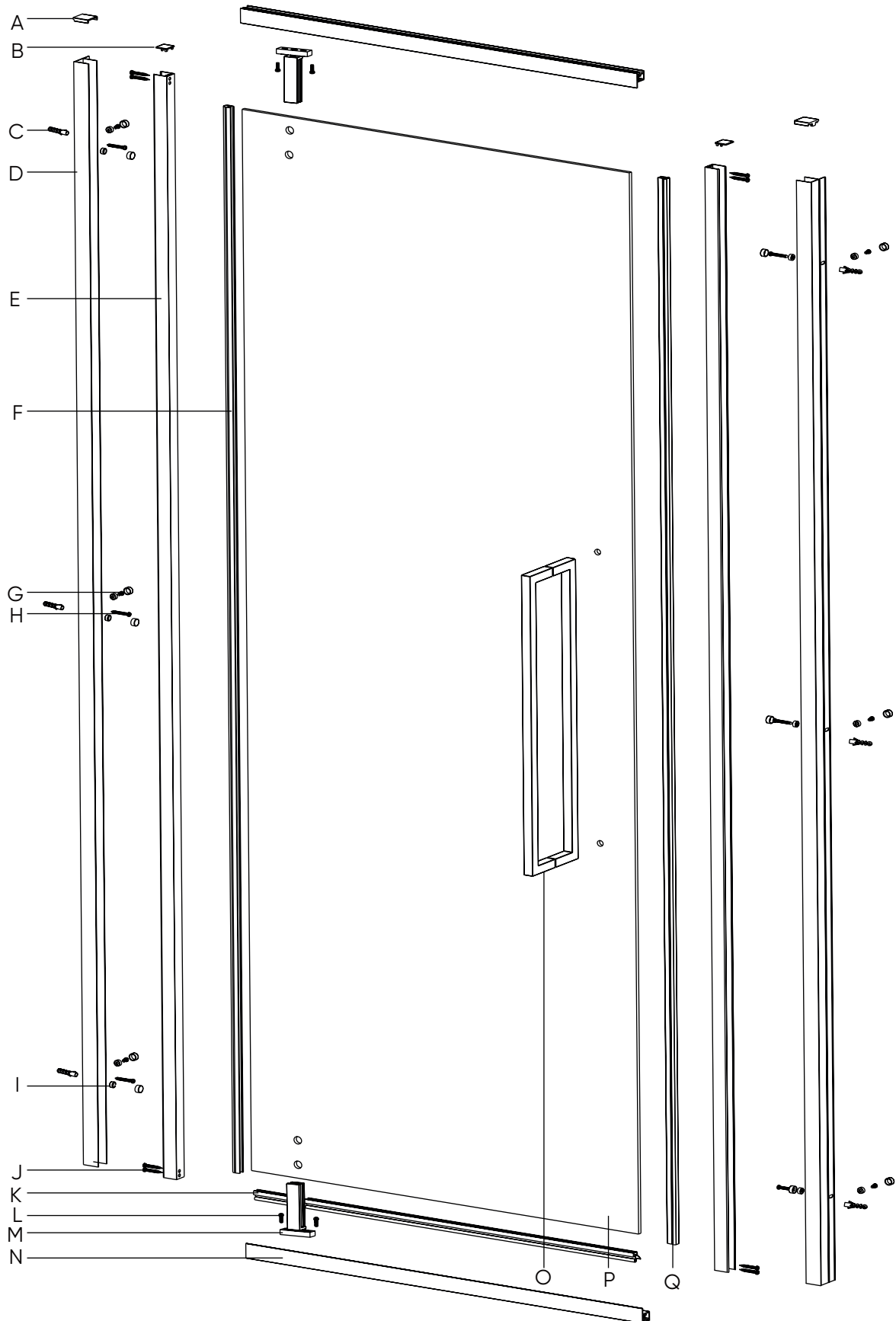



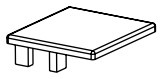
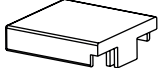

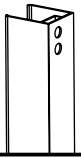
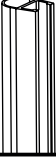

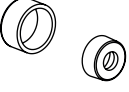
Правая ориентация

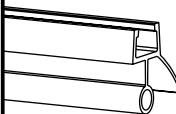
Общий вид душевой двери

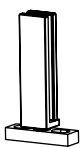

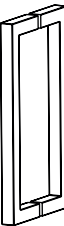
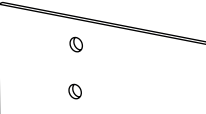
Перечень деталей

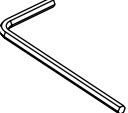
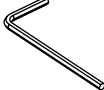
<p>Ax2</p> 	<p>Bx2</p> 	<p>Cx6</p> 	<p>Dx2</p> 
<p>Ex2</p> 	<p>Fx1</p> 	<p>Gx6</p>  ST4*8	<p>Hx6</p>  ST4*35
<p>Ix12</p> 	<p>Jx8</p>  ST4*25	<p>Kx2</p> 	<p>Lx4</p>  M4*10
<p>Mx2</p> 	<p>Nx2</p> 	<p>Ox1</p> 	<p>Px1</p> 
<p>Qx1</p> 	<p>x1</p>  4MM	<p>x1</p>  2.5MM	

Шаг 1

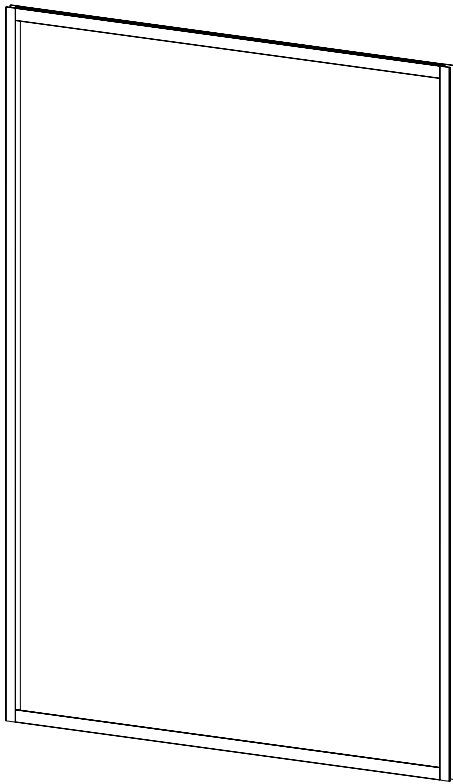

Артикул	Регулировка(мм)
VN33/33B-70-01-C7	690-710
VN33/33B-80-01-C7	790-810
VN33/33B-90-01-C7	890-910

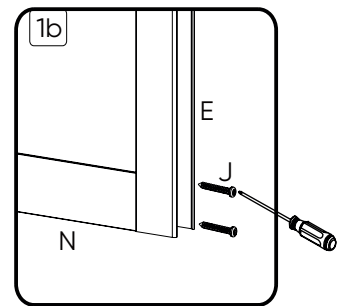
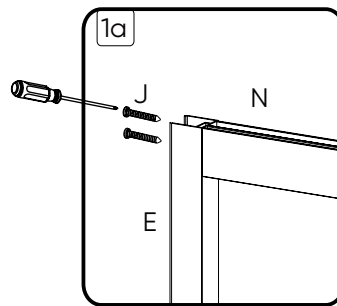

Шаг 2

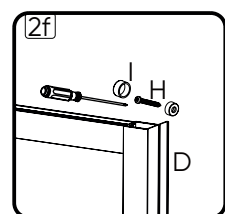
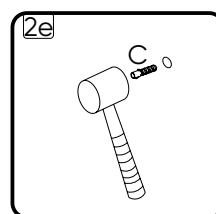
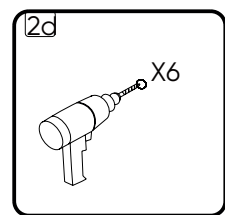
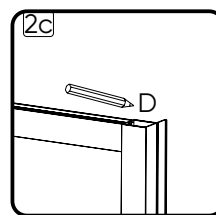
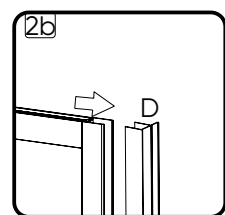
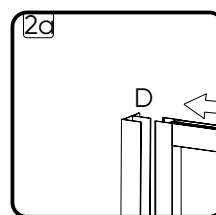
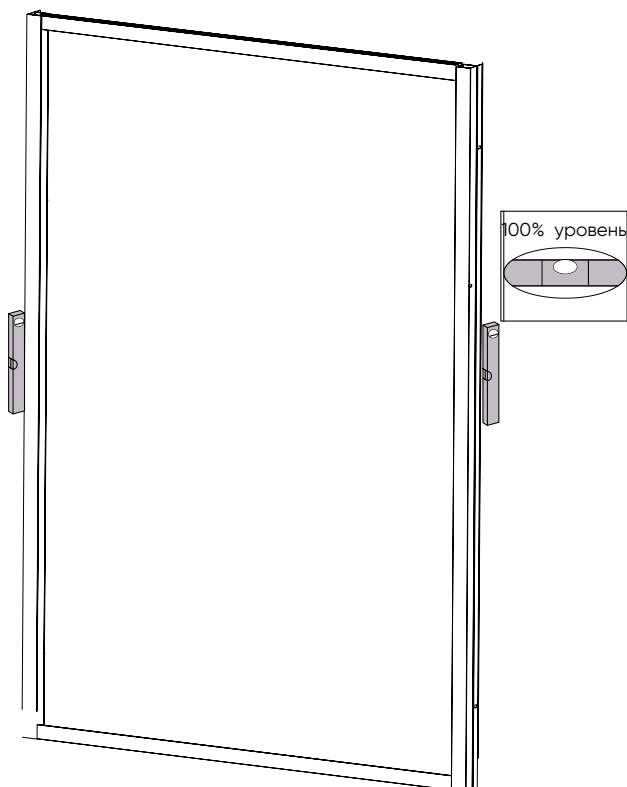

Шаг 3

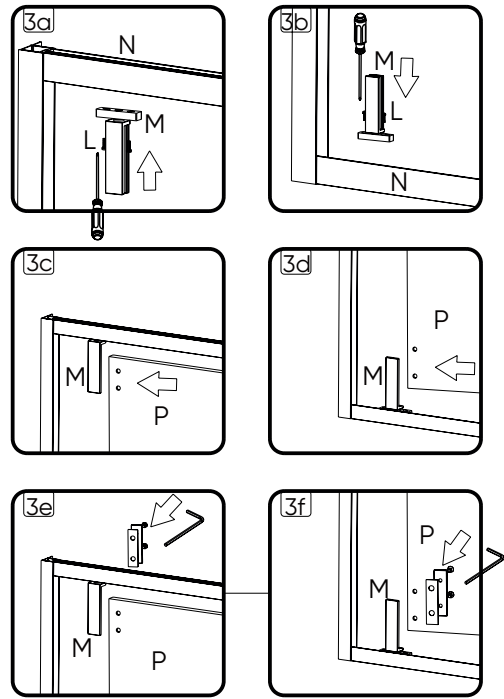
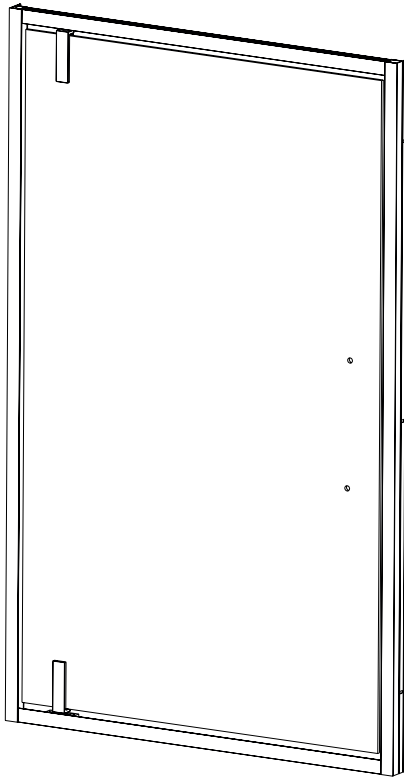

Шаг 4

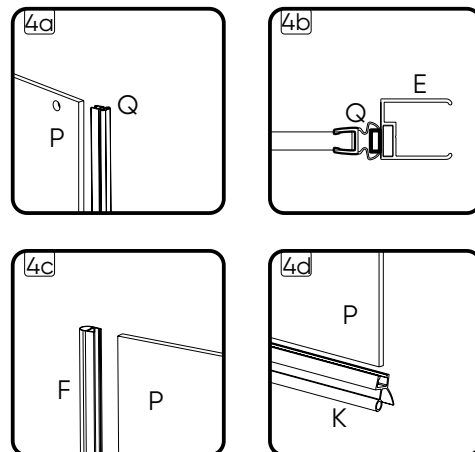
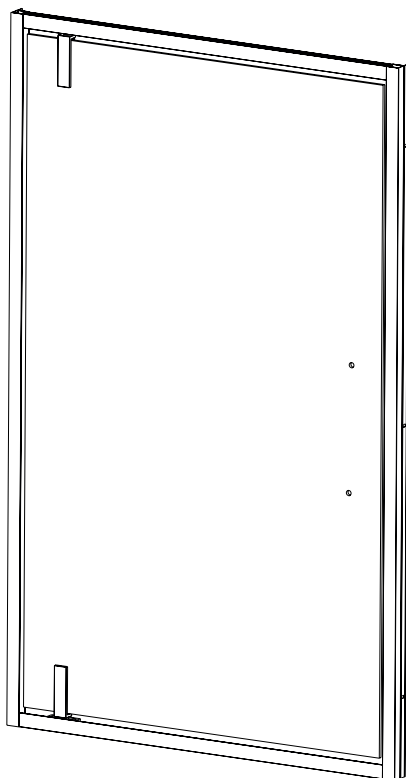

Шаг 5

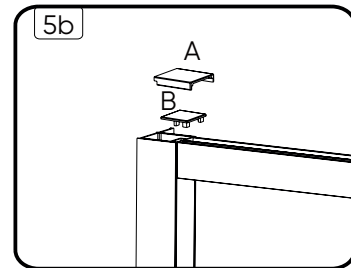
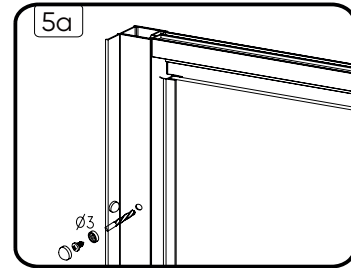
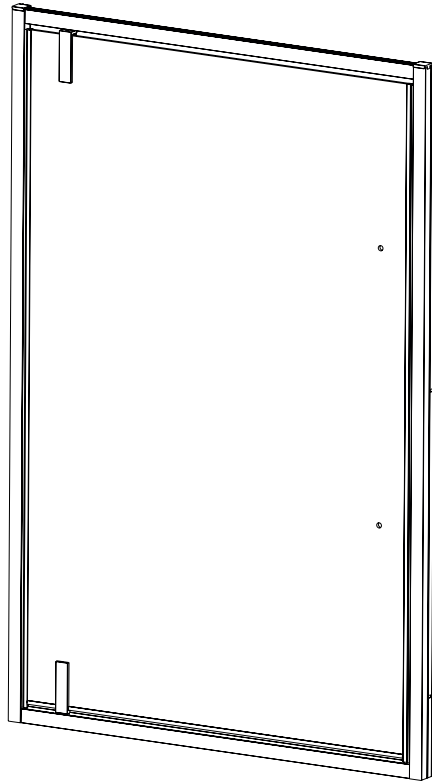

Шаг 6

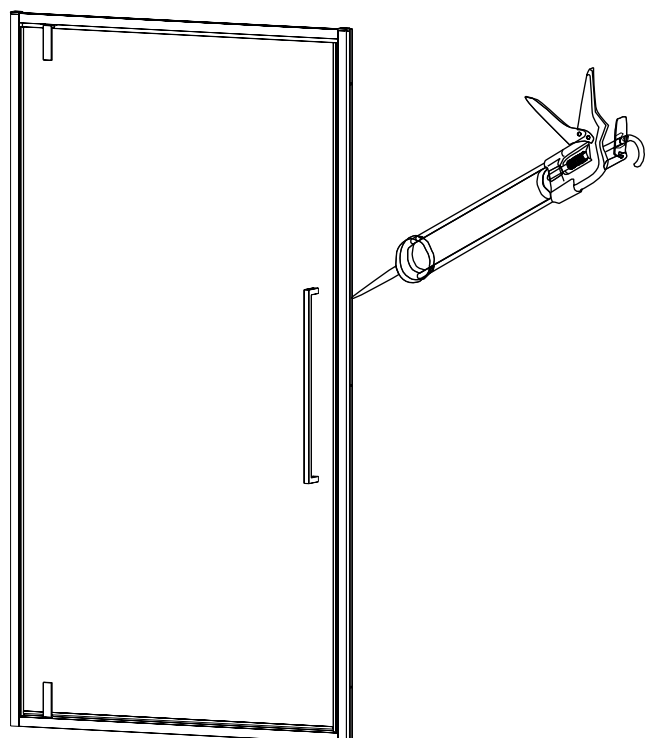
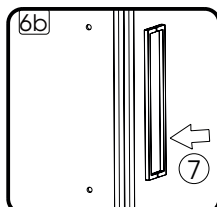
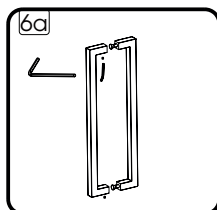

Достоверную информацию уточняйте на santehnica.ru.